

Adjective Agreement in Noon: Evidence for a Split Theory of Noun-Modifier Concord*

Nico Baier (UC Berkeley)
nbaier@berkeley.edu

NELS 45, MIT · October 31, 2014

1 Introduction

In this talk, I will be concerned with the following broad question:

Broad Question

Are all instances of agreement in derived by a single mechanism?

I approach this question from the point of view of noun-modifier agreement (often referred to as ‘concord’):

(1) Approaches to Noun-Modifier Agreement

- a. SYNTAX-CENTRIC: Many researchers attempt to unify subject-predicate agreement and noun-modifier agreement under the umbrella of Agree in the syntax proper (Baker 2008b; Carstens 2001, 2011, 2013; Danon 2011; Toosarvandani and van Urk 2012).
- b. MORPHOLOGY-CENTRIC: Another position, advocated by Norris (2014), takes noun-modifier agreement to operate in the morphological component. This approach splits noun-modifier concord from subject-predicate agreement derived by Agree.

While these accounts differ on where they locate noun-modifier agreement, they generally share a fundamental:

The Common Thread

Agreement between nouns and their modifiers inside DP are derived by the same mechanism.

Today, I will show that this view is untenable by examining noun-modifier agreement in Noon, a Cangin language spoken in Senegal. Adjectives in Noon exhibit two types of agreement with the noun they modify.

- They take a CONCORD PREFIX reflecting the class/number of the modified noun.
- They take a DEFINITE SUFFIX marking definiteness and class/number of the modified noun.

These two forms of agreement show an **asymmetrical distribution**, as shown in.

- The concord prefix is obligatory on all adjectives.
- The definite suffix cannot appear on adjectives in predicative position, but is obligatory in attributive adjectives in a definite DP.

*I thank Line Mikkelsen, Peter Jenks for insightful comments, guidance, and discussion on this project, as well as the audiences at Stanford’s Syntax and Morphology Circle and UC Berkeley’s Syntax and Semantics Circle for feedback. Thanks also to my Noon consultant for putting up with my questioning. All data in this presentation were gathered by the author and Jack Merrill through elicitation in Berkeley, CA in the Spring of 2014. Abbreviations: AGR = agreement; AN = animate; COP = copula; C# = class #; DEF = definite; DX# = degree of deixis; PST = past; REL = relative; SG = singular; PL = plural; 1 = class 1; 2 = class 2; 3 = class 3; 4 = class 4; 5 = class 5; 6 = class 6.

(2) a. **Attributive Position: Prefix + Suffix**

kann-faa fi-yak-(*faa)
 house-2S.DEF.DX2 2S-big-2S.DEF.DX2
 'the big house'

(3) a. **Predicative Position: Only Suffix**

kann-faa Ø fi-yak-(*faa)
 house-2S.DEF.DX2 COP 2S-big-2S.DEF.DX2
 'The house is big'

b. **Dominance + C-Command**

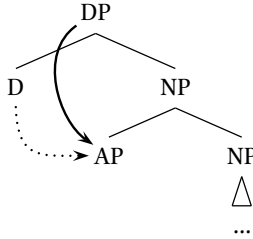

b. **Only C-Command**

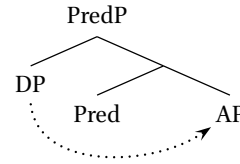

The generalization is that the two agreement morphemes are **subject to different forms of locality**:

- The concord prefix occurs whenever the adjective is **c-commanded** by D(P).
- The definite suffix only surfaces in cases where the adjective is included in DP, and therefore, only when it is **dominated** by DP.

The syntax-centric and morphology-centric approaches in (1) give us the machinery to derive this difference.

Main Claims

- Two mechanisms of agreement are necessary to derive the pattern of noun-modifier agreement observed in Noon.
- Agree, sensitive to c-command, derives the concord prefix.
- Morphological Feature Copying (Norris 2014), sensitive to dominance, derives the definite suffix.
- Both mechanism are active inside DPs.

Recent syntactic approaches to noun-modifier agreement have been **syntactic**, usually based on the operation Agree Chomsky's (2000)¹:

- Agreement morphemes on adjectives and other nominal modifiers spell out Probes that enter the derivation with unvalued/uninterpretable features that must be valued.
- Such approaches include: Baker (2008b), Carstens (2001, 2011, 2013), Danon (2011), and Toosarvandani and van Urk (2012, 2014).

Such accounts usually assume a modified version Agree to make it possible for modifiers to Agree upwards if necessary. For example, Baker (2008a) and Toosarvandani and van Urk (2012) both assume a version of (4):

(4) **Bidirectional Agree:**

A probe with an unvalued feature F on head H with Agrees with a goal G with a valued feature F only if H c-commands G or G c-commands H.

The morphological approach argues that noun-modifier agreement takes place post-syntactically:

- Norris (2014) proposes that agreement morphemes on adjectives and other nominal modifiers realize AGR-nodes ('agreement nodes'; Halle and Marantz 1993).
- AGR-nodes are inserted based on lexical specifications of certain heads.

¹There have been syntactic approaches not based on Agree. Mechanisms used in such approaches include Feature Checking (Carstens 2000; Mallen 1997); Spec-Head agreement (Koopman 2006); and Feature Unification (Grimshaw 1991; Svenonius 1993; Wechsler and Zlatic 2003). I only discuss the Agree based approaches here.

AGR-nodes are inserted with unvalued features. There is operation called Feature Copying which supplies these nodes with features from dominating heads:

- (5) **Feature Copying** (Norris 2014): For every unvalued feature [F:_] on an AGR-node Z_{AGR} , copy the value from a projection XP iff...
 - a. XP has a value for [F:_] ([F:α])
 - b. XP includes Z_{AGR}
 - c. There is no YP such that YP has a value for [F:~], YP dominates Z_{AGR} , and XP dominates YP (i.e., copy the closest value)

2 Background

2.1 Noun Classes

Each noun in Noon belongs to a lexically specified class. Class membership is largely signalled through concord morphemes.

CLASS	Definite		Concord		Animate	
	SG	PL	SG	PL	SG	PL
1	∅	c-	w-	c-	y-	b-
2	f-	c-	f-	c-	y-	b-
3	m-	c-	m-	c-		
4	k-	t-	k-	t-	y-	b-
5	p-	t-	p-	t-		
6	j-	t-	j-	t-	y-	b-

Table 1: Class Morphemes

- 6 singular class exponents.
- 2 plural class exponents.
- Cross-cutting animacy distinction marked by concord.
- I take “class” to be the spell out of two features: [GEN] and [NUM] (Carstens 1991).
- Here, class is glossed with class number + s/p indicating number

2.2 The Noon DP

The order of elements inside DP is shown in (6). Elements that show overt marking for the class of the head noun are boxed.

- (6) **Order of Elements in DP:** NOUN-(D) POSS NUM ADJ DEM RC/PP

Examples of such ordering is given in (7).

- (7) a. **kaan-fii** **fi-yoox-fii** **fi-yak-fii** **fii**
 house-2S.DEF.DX1 2S-red-2S.DEF.DX1 1S-big-2S.DEF.DX1 2S.DEM.DX1
 ‘this big red house’
- b. **tedik-tii** **taay-tii** **ti-yak-tii** **tii**
 tree.PL-4P.DEF.DX1 4P.three-4P.DEF.DX1 4P-big-4P.DEF.DX1 CL4PL.DEM.DX1
 ‘these three big trees.’

Definiteness is marked via a suffix on the head noun, as shown in (7a-d). As shown in Table 3, the definite suffix is composed of an initial consonant which marks the class/number of the head noun and a rhyme that indicates degree of deixis:

Deixis	Suffix
Near Speaker (DX1)	-Cii
Near Addressee (DX2)	-Cum
Distant (DX3)	-Caa

Table 2: Definite Suffixes

- (8) a. **kaan-fii**
 house-2S.DEF.DX1
 ‘the house (near me)’
- b. **kaan-fum**
 house-2S.DEF.DX2
 ‘the house (near you)’
- c. **kaan-faa**
 house-2S.DEF.DX3
 ‘the house (over there)’

The basic structure I assume for DP in Noon is given in (9a). I assume that the definite suffix instantiates the head D° and that successive head movement of $\sqrt{\text{ROOT}}$ to D° , through n° and Num° derives head-initial order, (10a):

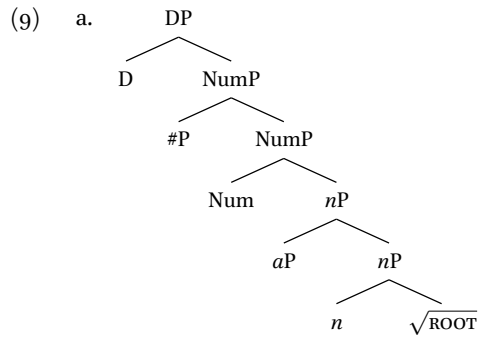

- b. Gender (GEN) is introduced on n° (Kramer 2010).
- c. Number (NUM) is introduced on Num° (CITE).
- d. Person, (π), definiteness (DEF), deixis features (DX) are introduced on D° .

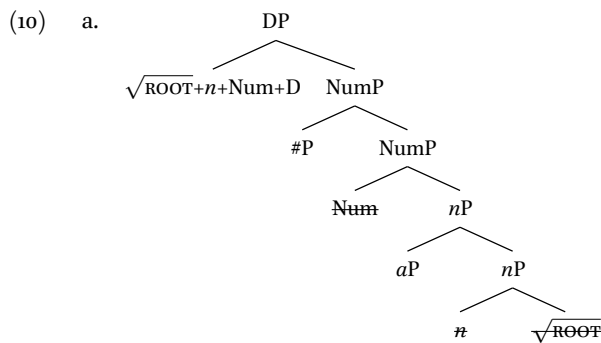

- b. $\sqrt{\text{ROOT}}$ head moves to D° via n° and Num°
- c. Derives head-initial order.
- d. Definite suffix on noun spells out D° .

Because the features of D° are available outside of DP, I assume that features project in the following ways²:

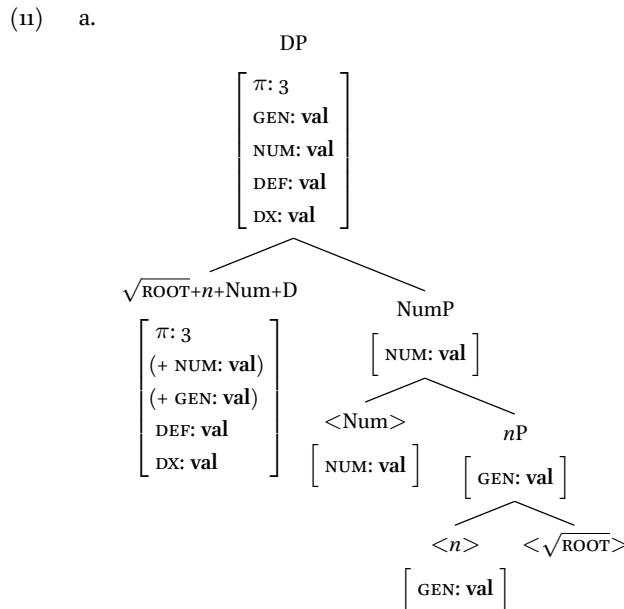

- b. All features of a head are projected to the XP level.
- c. For complex heads, all features of constituent heads are projected to the XP level.
- d. Ensures that a complete φ -bundle is created by head movement to D° in (10a)
- e. This complete φ -bundle is then accessible outside DP.

²See Norris (2014) for a detailed account of feature percolation/projection that is line with these principles.

I assume that all adjectives are derived from a acategorical root via the categorizing head a^0 . Thus, in the syntax, adjectives have the form in (12). I assume that adjectives in predicative position are the complement of the head Pred^0 , as shown in (13)

(12) Structure of an Adjective

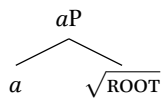

(13) Structure of adjectival predicates:

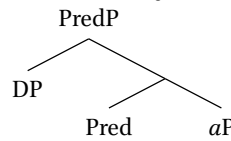

3 Noun-Adjective Agreement in Noon

Adjectives in Noon agree with the noun they modify for class/number. The adjective *sseti* ‘clean’ and *yak* ‘big’ in (14) exhibits two forms of agreement with the noun it modifies³:

- (14) otu-caa ci-seti'-caa ci-yak-caa
 car-1P.DEF.DX3 1P-clean-1P.DEF.DX3 1P-yak-1P.DEF.DX3
 ‘the big clean cars’

- *ci-* = the CONCORD PREFIX, which marks for class and number.
- *-caa* = the DEFINITE SUFFIX, which marks class, number, and deixis.

Adjective Agreement Distributional Asymmetry

- The CONCORD PREFIX is **obligatory** on adjectives both in attributive position and in predicative position.
- The DEFINITE SUFFIX is **obligatory** on attributive adjectives in definite contexts, but is **disallowed** on adjectives in predicative position.

(15) Indefinite Nouns

- a. oomaax *(yi)-jowi'
 child 1AN.S-good
 ‘a good child’
- b. oomaax ∅ *(yi)-jowi'
 child COP 1AN.S-good
 ‘A child is good.’

(16) Definite Nouns

- a. oomaan-aa yi-jowi'-*(yaa)
 child-1S.DEF.DX2 1AN.S-good-1AN.S.DEF.DX2
 ‘the good child’
- b. oomaan-aa ∅ yi-jowi'-*(yaa)
 child-1S.DEF.DX2 COP 1AN.S-good-1AN.S.DEF.DX2
 ‘the child is good’

3.1 The Concord Prefix

The concord prefix has the form *Ci-*, where *C-* marks the class/number of the modified noun:

(17) The Concord Prefix

- a. kop wi-newi'
 palm.wine 1S-tasty
 ‘tasty palm wine (Class 1,SG = w-)
- b. kaan fi-yak
 house 2S-big
 ‘a big house’ (Class 2,SG = f-)
- c. miip mi-'aay
 sauce 3S-spicy
 ‘spicy sauce’ (Class 3,SG = m-)
- d. kedik ki-xiilii
 tree 4S-green
 ‘a green tree’ (Class 4,SG = k-)

³As noted in section 2, numerals and demonstratives also agree with the head noun for class/number. Numerals display prefixal and suffixal agreement like adjectives, while demonstratives only show class/number agreement. I will leave these two categories to further work, and focus on adjectives here.

- e. pílket [pi]-xóodí'
thread 5S-long
'a long thread' (Class 5, SG = p-)
- f. jokun [ji]-xóodí'
finger 5S-long
'a long finger' (Class 6, SG = j-)

The prefix is obligatory on all attributive adjectives when there are multiple adjectives, (18). It is also obligatory on adjectives in predicative position, regardless of definiteness, (19):

(18) **Concord prefix on attributive adjective**

- a. otu wi-yak wi-seti' wi-séedí'
car 1S-big 1S-clean 1S-expensive
'a big, clean, expensive car'
- b. *otu [Ø]-yak wi-seti' wi-séedí'
- c. *otu wi-yak [Ø]-seti' wi-séedí'
- d. *otu wi-yak wi-seti' [Ø]-séedí'

(19) **Concord prefix on predicate adjective**

- a. otu enee wi-seti'
car COP.PST 1S-clean
'a car was clean'
- b. *otu enee [Ø]-seti'
- c. otu-ii enee wi-seti'
car-1S.DEF.DX1 COP.PST 1S-clean
'the car was clean'
- d. *otu-ii enee [Ø]-seti'

I take these data to support the conclusion that the concord prefix found on adjectives is agreement with the class/number of the modified noun.

3.2 The Definite Suffix

Attributive adjectives in a definite DP must take a definite suffix. The definite suffix on adjectives is identical to the determiner on the head noun:

Deixis	Noun	Adjective
Near Speaker (DX1)	-Cii	-Cii
Near Addressee (DX2)	-Cum	-Cum
Distant (DX3)	-Caa	-Caa

Table 3: Definite Suffixes

(20) **The Definite Suffix**

- a. kop-ii wi-newi'-[wii]
palm.wine-1S.DEF.DX1 1S-tasty-1S.DEF.DX1
'the tasty palm wine'
- b. kaan-faa fi-yak-[faa]
house-2S.DEF.DX3 2S-big-2S.DEF.DX2
'a big house'
- c. miip-mum mi-'aay-[mum]
sauce-3S.DEF.DX2 3S-spicy-3S.DEF.DX2
'spicy sauce'
- d. kedik-kii ki-xiilii-[kii]
tree-4S.DEF.DX1 4S-green-4S.DEF.DX1
'a green tree'
- e. pílket-paa pi-xóodí'-[paa]
thread-5S.DEF.DX3 5S-long-5S.DEF.DX3
'a long thread'
- f. jokun-jii ji-xóodí'-[jii]
finger-5S.DEF.DX1 5S-long-5S.DEF.DX1
'a long finger'

There is good evidence that the definite suffix is a form of agreement (as argued for multiple definiteness marking in Amharic by Kramer 2010).

- (21) **Argument 1: The Definite suffix is obligatory on all Adj**
- a. ✓ baay-faa fi-jowi'-faa fi-yaak-faa
 dog-2S.DEF.DX3 2S-good-2S.DEF.DX3 2S-big-2S.DEF.DX3
 'the good big dog'
- b. * baay-faa fi-jowi'-∅ fi-yaak-faa
- c. * baay-faa fi-jowi'-faa fi-yaak-∅
- d. * baay-faa fi-jowi'-∅ fi-yaak-∅

- (22) **Argument 2: Definite suffix on Adj alone ≠ Definite DP**

- a. ✓ baay-faa fi-suus-faa
 dog-2S.DEF.DX3 2S-black-2S.DEF.DX3
 'the black dog'
- b. * baay fi-suus-faa
 dog 2S-black-2S.DEF.DX3
 Intended: 'the black dog'

- (23) **Argument 3: Deixis features must match exactly**

- a. * baay-faa fi-suus-fi
 dog-2S.DEF.DX3 2S-black-2S.DEF.DX1
 Intended: 'the black dog'
- b. * baay-fi fi-suus-faa
 dog-2S.DEF.DX1 2S-black-2S.DEF.DX3
 Intended: 'the black dog'

The data in (21)-(23) rule out an analysis of the definite suffix on adjectives as recursion of a D^o or close apposition of multiple DPs.

- Both approaches have been applied to Greek polydefinites, another type of multiple definiteness marking in DP (Alexiadou and Wilder 1998 and Lekakou and Szendroi 2011, respectively).

Furthermore, the definite suffix on adjectives should not be analyzed as a type of *ezafe* or linker construction, as it only occurs on adjectives and numerals. No other nominal modifier (possessors, PPs) takes the definite suffix in a definite DP:

- (24) a. * baay-fi-n [Kodu]_{POSS}-fi
 dog-2S.DEF.DX1-POSS Kodu-2S.DEF.DX1
 Intended: 'Kodu's dog'.
- b. * kaan-fi-n [ga Caañaak]-fi
 house-2S.DEF.DX1-POSS [PP P.LOC Thies]-2S.DEF.DX1
 Intended: 'the house in Thies'.

If the definite suffix on adjectives were a type of predicational linker required in nominal modification structures, as argued by Dikken and Singhapreecha (2004) for *ezafe* constructions, we would expect to find it with all types of nominal modifiers, not just a subset ⁴.

Conclusion

The definite suffix on attributive adjectives is *definiteness agreement* with the head noun.

⁴See Jenks (2014) for other arguments against such an approach.

Definiteness agreement is **disallowed** when an adjective is in predicative position, as shown in (25):

(25) **Definite N, Predicative Adj**

- a. kaan-faa enee fi-suus-*faa/✓∅
 house-2S.DEF.DX3 COP.PST 2S-black-2S.DEF.DX3
 ‘the house was black’

- b. kedik-kaa ∅ ki-yaak-*kaa/✓∅
 tree-4S.DEF.DX3 COP 4S-woman-4S.DEF.DX3
 ‘the tree is big’

Thus, even though the definiteness suffix is a form of agreement, it is a form of agreement that **fails** where another form of agreement, the concord prefix **succeeds**.

3.3 Summary

There is an asymmetry in the distribution of adjectival agreement: the concord prefix occurs in both attributive and predicative contexts. The definite suffix only occurs on attributive adjectives. These facts are summarized in Table 4 and Table 5:

	ATTR	PRED
PREFIX	<i>Ci-ADJ</i>	<i>Ci-ADJ</i>
SUFFIX	<i>Ci-ADJ-Cii/aa/um</i>	<i>Ci-ADJ</i>

Table 4: Distribution of Adjectival Agreement

	ATTR	PRED
PREFIX	✓	✓
SUFFIX	✓	✗

Table 5: Distribution of Adjectival Agreement

Question

What derives the distributional asymmetry between the concord prefix and the definiteness suffix?

4 A Split Analysis of Noon Adjectival Agreement

In this section, I argue that the concord prefix and the definite suffix are not derived by the same grammatical operation:

The Proposal

- The CONCORD PREFIX spells out a syntactic probe that is merged on a° . This probe is valued by Agree, and is thus sensitive to c-command.
- The DEFINITE SUFFIX spells out an AGR-node that is inserted onto a° in the morphology. This probe is valued by Feature Copying, and is thus sensitive to dominance/inclusion.

Technology Required

- **Bidirectional Agree** (Baker 2008b): Probes can be valued by c-commanding featres.
- **AGR-node** insertion (Halle and Marantz 1993; Kramer 2010; Norris 2014): Agreement nodes can be inserted into X° in the morphological component.
- **Feature Copying** (Norris 2014): Features on AGR-nodes valued by copying values of matching features from dominating XP nodes.

4.1 Concord Prefix = Syntactic Probe

I propose that the concord prefix on adjectives is derived in the following way:

- All a° are merged with a syntactic probe unvalued for GENDER FEATURES and NUMBER FEATURES.
- In the case of attributive adjectives, this probe will find matching features on the complex D° , as shown in (26).
- In the case of predicate adjectives, the probe can again find a matching feature, this time on the DP in subject position, as shown by (27).

(26) Prefix probe on a° finds D°

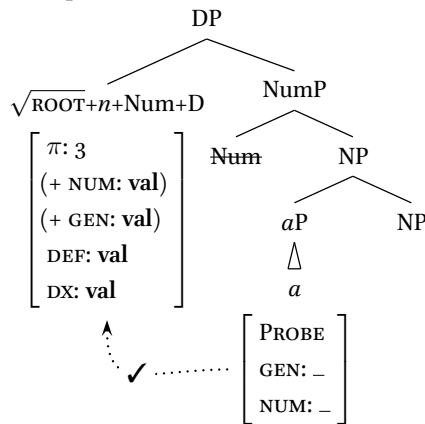

(27) Prefix probe on a° finds DP

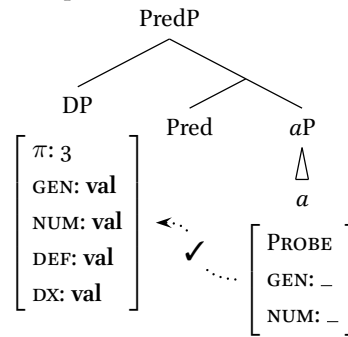

This analysis ensures that the syntactically active probe on a° always finds the matching features. This is possible because of Bidirectional Agree, shown in (40). As long as the adjective can probe up, it will find the features it needs.

(28) Bidirectional Agree:

A probe with an unvalued feature F on head H with Agrees with a goal G with a valued feature F only if H c-commands G or G c-commands H.

Note!

If a probe in the syntax derived the definite suffix as well, it would be unclear why the definite suffix does not appear in predicative position. This is because the probe for the definite suffix should be able to succeed in (27), just as the concord prefix probe does.

4.2 Definite Suffix = Agr-node

I propose that the definite suffix on adjectives is an AGR-node inserted onto a° in the morphology:

- Following Norris (2014), AGR-node insertion is triggered by lexical categories, here taken to be a, ν, n .
- The definite suffix on adjectives realizes an AGR-node that is inserted onto a° at Transfer.

Insertion of such a morpheme is governed by a rule of the type in (29)⁵. The AGR-node enters the morphology unvalued for certain features, this, shown in (30):

(29) AGR-node insertion: $[X^\circ X] \rightarrow [X^\circ [X^\circ X] \text{AGR}]$

(30) AGR-node for a° in Noon = $\begin{bmatrix} \text{GEN: } - \\ \text{NUM: } - \\ \text{DEF: } - \\ \text{DX: } - \end{bmatrix}$

⁵See Kramer (2010) and Norris (2014) for discussion of AGR-node insertion rules of this type.

After insertion of the AGR-node in (30) on a^o , Feature Copying, given in (31), copies the values of dominating, matching features to AGR-node. This process is shown in detail in (32a):

- (31) **Feature Copying** (Norris 2014): For every unvalued feature $[F:-]$ on an AGR-node Z_{AGR} , copy the value from a projection XP iff...
- XP has a value for $[F:-]$ ($[F:\alpha]$)
 - XP includes Z_{AGR}
 - There is no YP such that YP has a value for $[F:-]$, YP dominates Z_{AGR} , and XP dominates YP (i.e., copy the closest value)

(32) **Feature Copying values AGR-node on a**

a.

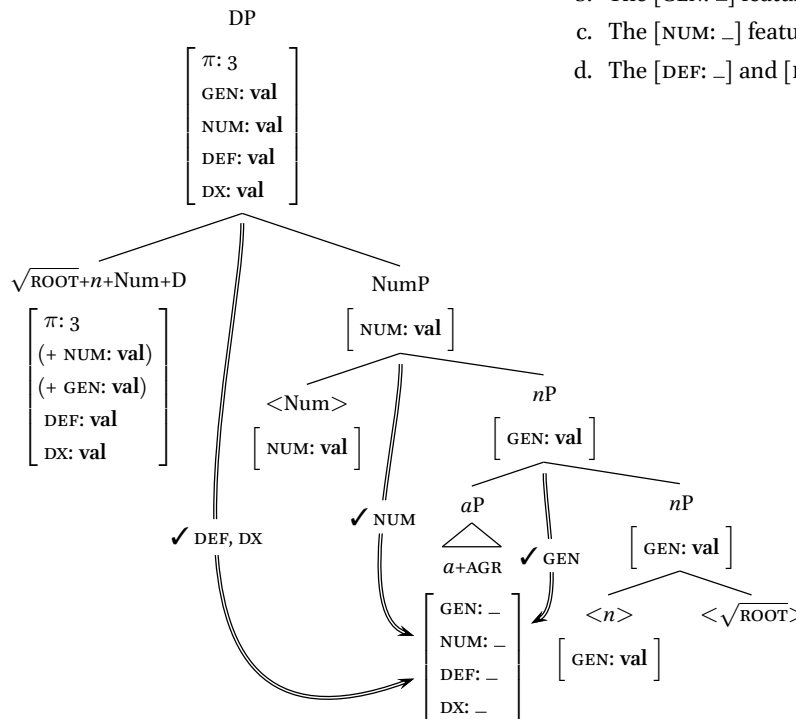

- The $[GEN: -]$ feature is valued from nP .
- The $[NUM: -]$ feature is valued from NumP.
- The $[DEF: -]$ and $[DX: -]$ features are valued from DP.

When an adjective is in predicative position the requisite dominance relation in (31c) is not present. Thus, no features can be copied to the value-less AGR-node adjoined to a , as shown in (33):

(33) **Feature Copying cannot value AGR-node on a -**

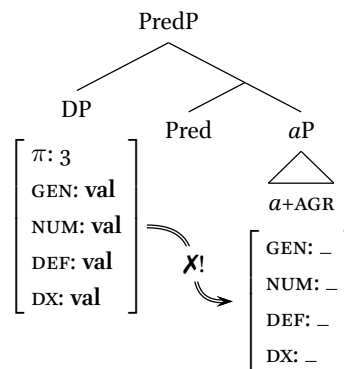

The configuration in (33) results in the AGR-node not having any values. I assume that the node is given a *default value* for all its features when this is the case:

- I assume the default valued for [DEF] is indefinite: [DEF: -]
- I do not take a position on the default values for [GEN], [NUM], and [DX]⁶.

Importantly, this process of default valuation of the AGR-node ensures that the [DEF] value of AGR-nodes in predicative position are identical to the [DEF] value of AGR-nodes in indefinite DPs.

Note!

If both morphemes were AGR-nodes, we would not expect to see any (non-default) agreement on adjectives in predicative position. This is because neither morpheme would be dominated by matching features, and thus would receive default values.

4.3 The Result

Once the AGR-node on a^o has been valued, I take an adjective to have the structure in (34):

(34) Structure of an Adjective at VI

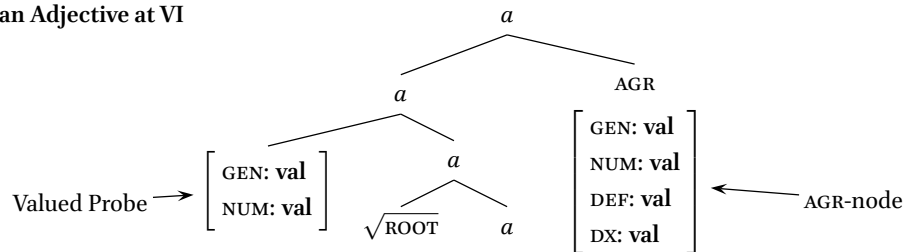

The left adjoined node is the probe merged on a^o in the syntax⁷. The right adjoined node is the AGR-node inserted in the morphology.

- The prefixal node is spelled out as a the concord prefix, with the values of [GEN] and [NUM] determining the class consonant.
- The suffix node is spelled out as a definite suffix if it has a [DEF: +] feature. This is only possible in definite DPs, where a [DEF: +] is available. The [GEN], [NUM], and [DX] features determiner the shape of the suffix.
- The suffixal node is not spelled out if it has a [DEF: -] feature. This occurs when it is in an indefinite DP or when the adjective is in predicative position.

Predictions of a Split Analysis

- The CONCORD PREFIX will always appear because it always receives a value in the syntax.
- The DEFINITE SUFFIX will only surface when the adjective is attributive, and furthermore only in definite DPs.

Thus, the split analysis correctly predicts the distribution of adjectival agreement morphemes, as shown in Tables 6 and 7:

	ATTR	PRED
PREFIX	✓	✓
SUFFIX	✓	✗

Table 6: Split Analysis

	ATTR	PRED
PREFIX	✓	✓
SUFFIX	✓	✗

Table 7: Observed Distribution

⁶An alternative would be to say that the the [GEN] and [NUM] features on the AGR-node are always valued by the features present on a^o itself. I leave this option open for now.

⁷I assume that a process of such as Fission (Halle and Marantz 1993) is responsible for splitting the probe off from the rest of a^o

5 Extensions

The analysis developed for Noon in the previous section can be extended to explain cross-linguistic differences in noun-adjective agreement. For example, there is a well known difference between Romance languages, such as Spanish, and west Germanic languages such as German:

(35) **Spanish: Agreement in attributive and predicative position. No definiteness sensitivity**

- a. un niño alt-o
 a.MASC boy tall-MASC
 ‘a tall boy’ (SG, MASC, INDEF; Schoorlemmer 2009)
- b. el niño alt-o
 the.MASC boy tall-MASC
 ‘a tall boy’ (SG, MASC, DEF; Schoorlemmer 2009)
- c. el niño es alt-o
 the.MASC boy is tall-MASC
 ‘the boy is tall’ (SG, MASC, DEF; Schoorlemmer 2009)

(36) **German: Attributive agreement sensitive to definiteness; No agreement in predicative position**

- a. ein gut-es Buch
 a.NEUT good-NEUT.SG.INDEF book
 ‘a good book’ (ATTR, INDEF)
- b. das gut-e Buch
 the.NEUT good-DEF book
 ‘a tall boy’ (ATTR, DEF)
- c. das Buch ist gut-∅
 the.MASC boy is tall-MASC
 ‘the book is good’ (PRED, DEF)

The theory developed in this talk explains this difference in the following way:

- Spanish: a° is **always** merged with a syntactic φ -probe. No AGR-node is inserted onto a° . Agreement will always surface.
- German: a° **never** has a φ -probe, but an AGR-node specified for [DEF] is inserted onto a° . Therefore, agreement will only appear when the adjective is attributive.

Further, Scandinavian languages, such as Swedish in (37), exhibit a pattern similar to Noon:

(37) **Swedish: Attributive agreement sensitive to definiteness. Predicative agreement shows indefinite agreement.**

- a. ett stor-t hus
 a big-NEUT.SG.INDEF house
 ‘a big house’ (SG, NEUT, INDEF) (Schoorlemmer 2009)
- b. det stor-a hus-et
 a big-DEF house
 ‘a tall boy’ (SG, MASC, DEF) (Schoorlemmer 2009)
- c. hus-et är stor-t
 house-DEF.NEUT.SG is big-NEUT.SG.INDEF
 ‘the book is good’ (SG, MASC, DEF) (Schoorlemmer 2009)

I propose that in Swedish, like in Noon, the head a° is merged with a syntactic φ -probe and *also* triggers AGR-node insertion (and those AGR-NODES are sensitive to definiteness).

- When the AGR-node has a value [DEF:+], definite adjective ending *-a* is used.
- Elsewhere, the indefinite form is used.

	ATTR	PRED
INDEF	✓	✓
(DEF)	✓	✓

Table 8: Spanish/Romance

	ATTR	PRED
INDEF	✓	✗
DEF	✓	✗

Table 9: German

	ATTR	PRED
INDEF	✓	✓
DEF	✓	✗

Table 10: Swedish/Noon

6 Conclusions

Noon adjectives exhibit two forms of agreement, but they have an asymmetric distribution:

- The concord prefix appears in attributive and predicative contexts
- the definite suffix cannot appear on adjectives in predicative position.

I have shown that two mechanisms of agreement are necessary to derive the distribution of agreement morphemes on adjectives in Noon. I have proposed:

- The concord prefix spells out a syntactic probe that is valued by Agree in the narrow syntax.
- The definite suffix spells out an AGR-node that is adjoined to *a* in the morphology. This node receives its value by Feature Copying (Norris 2014).
- Contra (Norris 2014), both these mechanisms are active in deriving attributive adjective agreement inside DP.

The analysis of Noon adjective agreement developed in this talk supports two conclusions with respect to the nature of agreement:

- There is not a one-to-one correlation between agreement morphemes and applications of Agree in the syntax. Agreement morphemes can arise from other operations as well (a view also put forward by Chung 2012).
- Agreement is not located in a single module of the grammar. We should recognize agreement in the narrow syntax and agreement in the morphological component.

References

- Alexiadou, Artemis, and Chris Wilder. 1998. Adjectival modification and multiple determiners. In *Possessors, predicates and movement in the determiner phrase*, ed. Artemis Alexiadou and Chris Wilder, 305–332. Amsterdam: John Benjamins Publishing Company.
- Baker, Mark C. 2008a. On the nature of the Antiagreement effect: Evidence from wh-in-situ in Ibibio. *Linguistic Inquiry* 39:615–632.
- Baker, Mark C. 2008b. *The syntax of agreement and concord*. Cambridge University Press.
- Carstens, Vicki. 1991. The morphology and syntax of determiner phrases in Kiswahili. Doctoral Dissertation, University of California, Los Angeles.
- Carstens, Vicki. 2000. Concord in Minimalist theory. *Linguistic Inquiry* 31:319–355.
- Carstens, Vicki. 2001. Multiple agreement and case deletion: Against *phi*-(in)completeness. *Syntax* 4:147–163.
- Carstens, Vicki. 2011. Hyperagreement and hyperactivity in bantu. *Lingua* 31:319–355.
- Carstens, Vicki. 2013. Delayed valuation: a reanalysis of "upwards" complementizer agreement and the mechanics of case. ms., University of Missouri.
- Chomsky, Noam. 2000. Minimalist inquiries: The framework. In *Step by step: Essays on minimalist syntax in honor of Howard Lasnik*, ed. Roger Martin, David Michaels, and Juan Uriagereka, 89–156. MIT Press.
- Chung, Sandra. 2012. On reaching agreement late. In *CLS 48: Papers from the Parasessions*.
- Danon, Gabi. 2011. Agreement and DP-internal feature distribution. *Syntax* 14:297–317.
- Dikken, Marcel den, and Pornsiri Singhapreecha. 2004. Complex Noun Phrases and linkers. *Syntax* 7:1–54.
- Grimshaw, Jane. 1991. Extended projection. Unpublished manuscript, Brandeis University.
- Halle, Morris, and Alec Marantz. 1993. Distributed morphology and the pieces of inflection. In *The view from building 20*, ed. Kenneth Hale and Samuel Jay Keyser, 111–176. Cambridge, Massachusetts: MIT Press.
- Jenks, Peter. 2014. Generalized clausal modifiers in thai noun phrases. *Syntax*.

Koopman, Hilda. 2006. Agreement configurations: in defense of “spec head”. In *Agreement systems*, ed. Cedric Boeckx, 159–199. Benjamins.

Kramer, Ruth. 2010. The Amharic definite marker and the syntax-morphology interface. *Syntax* 13:196–240.

Lekakou, Maria, and Kriszta Szendroi. 2011. Polydefinites in greek: Ellipsis, close apposition and expletive determiners. *Journal of Linguistics* 48:107–149.

Mallen, Enrique. 1997. A minimalist approach to concord in noun phrases. *Theoretical Linguistics* .

Norris, Mark. 2014. A Theory of Nominal Concord. Doctoral Dissertation, UCSC.

Schoorlemmer, Erik. 2009. Agreement, Dominance and Doubling: The morphosyntax of DP. Doctoral Dissertation, Leiden University.

Svenonius, Peter. 1993. Selection, adjunction, and concord in the dp. *Studia Linguistica* 47:198–220.

Toosarvandani, Maziar, and Coppe van Urk. 2012. Directionality and intervention in nominal concord: Evidence from zazaki ezafe. Handout version of a poster at NELS 43, CUNY.

Toosarvandani, Maziar, and Coppe van Urk. 2014. Agreement in zazaki and the nature of nominal concord. MS.

Wechsler, Stephen, and Larisa Zlatic. 2003. *The many faces of agreement*. *csl publications*.. CSLI Publications.

Appendix: Hypothetical Unified Accounts

There are two major types of approaches to noun-modifier agreement, specifically with regards to what mechanism drives this agreement.

(38) Approaches to Noun-Modifier Agreement

- a. SYNTAX-CENTRIC Many researchers attempt to unify subject-predicate agreement and noun-modifier agreement under the umbrella of Agree in the syntax proper (Baker 2008b; Carstens 2001, 2011, 2013; Danon 2011; Toosarvandani and van Urk 2012).
- b. MORPHOLOGY-CENTRIC Another position, advocated by Norris (2014), takes noun-modifier agreement to operate in the morphological component. This approaches splits noun-modifier concord from subject-predicate agreement derived via Agree.

Question

Can a unified approach to noun-adjective agreement derive the asymmetrical distribution of agreement morphemes in Noon?

All things being equal, a positive answer to the above question would be desirable, as we would only need one agreement mechanism to derive the distribution of Noon noun-adjective agreement.

Against a Unified Approach

A unified approach to noun-adjective agreement in Noon is untenable. It cannot derive the observed distribution of agreement morphemes

6.1 Hypothetical Syntactic Account

A syntactic approach would take agreement in the verbal and nominal domains to arise by the same mechanism, which I take here to be Agree Chomsky (2000).

- Given the architecture of Agree, we assume that agreement morphemes spell-out valued PROBES on a head.
- Thus, each (potential) agreement morpheme on an adjective in Noon would represent a separate probe merged on a^0 :

(39) Adjective with two probes

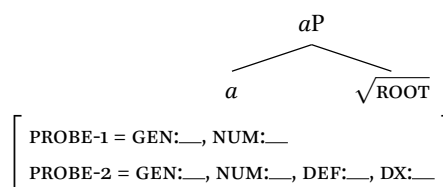

- Above, PROBE-1 represents the concord prefix, while PROBE-2 represents the definite suffix.

Following Baker (2008b) and Toosarvandani and van Urk (2012), I assume a bidirectional version of Agree:

(40) **Bidirectional Agree:**

A probe with an unvalued feature F on head H with Agrees with a goal G with a valued feature F only if H c-commands G or G c-commands H.

The version of Agree in (40) allows probes on *a* to find valued features upward.

- In attributive position, the probes on *a*^o can both find features on the complex head at D, as shown in (41).
- The same should be the case in predicative configuration, where the subject DP c-commands *a*P in the complement of PredP, as shown in(42).

(41) **Probes on *a* find D^o**

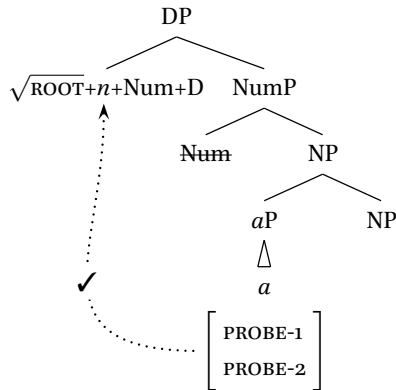

(42) **Probes should both succeed!**

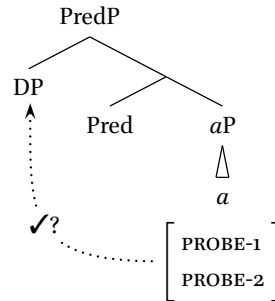

However, we know that both probes in (42) **cannot** succeed.

- In predicative contexts, only the concord prefix (= PROBE-1) can appear. The suffix, PROBE-2, cannot appear.
- Thus, PROBE-2 must have failed to find matching features.
- There is nothing about the configuration in (42) that explains this failure.

The unified syntactic account predicts the distribution of agreement in Table 4. This is clearly wrong, since the observed distribution is that shown in Table 5:

	ATTR	PRED
PREFIX	✓	✓
DEFINITE	✓	✓

Table 11: Unified Agree

	ATTR	PRED
PREFIX	✓	✓
DEFINITE	✓	✗

Table 12: Observed Distribution

6.2 Hypothetical Morphological Account

Norris (2014) proposes that DP internal noun-modifier agreement is mediated by a different operation than Agree and that this operation is POST-SYNTACTIC:

- Agreement morphemes on nominal modifiers spell-out AGR-nodes inserted on lexically specified heads post-syntactically.
- AGR-nodes enter the morphology unvalued for specific features.
- Features on AGR-nodes are valued by an operation of Feature Copying, shown above in (31)

Because agreement morphemes on nominal modifiers are uniformly AGR-nodes in Norris’s account, I assume that in the morphology, two AGR-nodes are adjoined onto *a*, simplified in (43):

- AGR-1 represents the concord prefix.
- AGR-2 represents the definite suffix.

(43) **Adjective with two AGR-NODES**

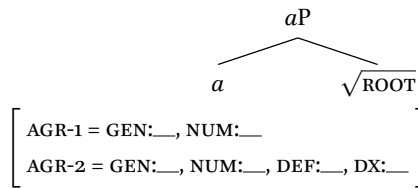

The Feature Copying operation copies the values of the closest dominating features to matching features on the AGR-nodes.

- Attributive adjectives are always able to have their AGR-nodes valued, as shown in (44).
- In predicative position, no matching features dominate the AGR-nodes.
- Thus, Feature Copying cannot occur when an adjective is predicative position. This is shown in (45):

(44) **Copying to *a*° successful in DP**

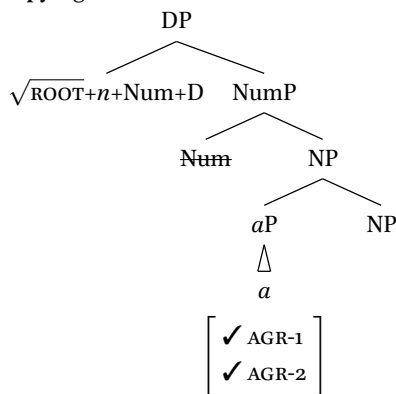

(45) **Copying to AGR impossible!**

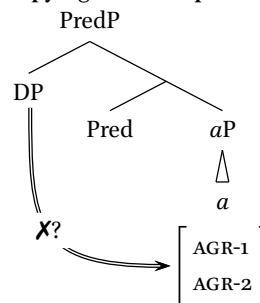

We know that one of the agreement morphemes in (45) **does** surface.

- In predicative contexts, the concord prefix (= AGR-1) always appears. The suffix, AGR-2, cannot appear.
- Thus, AGR-1 must have had features copied to it.
- Without a dominating projection hosting matching features, it is unclear where AGR-1s gets its features.
- There is nothing about the configuration in (42) that explains this asymmetry.

And, a unified approach fails to produce the correct distribution. Compare Table 6 to Table 7:

	ATTR	PRED
PREFIX	✓	✗
SUFFIX	✓	✗

Table 13: Unified Copying

	ATTR	PRED
PREFIX	✓	✓
SUFFIX	✓	✗

Table 14: Observed Distribution